

**NEMA 4X - ENCLOSURE
19" RACKMOUNT - 18U
FLOOR MOUNT**

**36" H x 48" W x 48" D
4 DOOR DESIGN**



FILE NUMBER: E507642

STAINLESS STEEL

- ENCLOSURE MATERIAL**
- 304 STAINLESS STEEL (S4) AIR CONDITIONER (OPTION) REF. TO PAGE 2
 - 316 STAINLESS STEEL (S6)

- CORROSION PROTECTION PACKAGE**
- EXTERIOR PASSIVATION (STANDARD)
 - INTERIOR/EXTERIOR PASSIVATION (OPTION)
 - NOT REQUIRED (ON REQUEST ONLY)

- POWDERCOAT COLOR**
- WHITE
 - LIGHT GRAY ANSI 70
 - DARK GRAY ANSI 61
 - BLACK
 - CUSTOM _____

- ENCLOSURE CONSTRUCTION**
- 14 GA THK.
 - 12 GA THK.

- ENCLOSURE DOOR HINGE**
- CONTINUOUS PIANO HINGE (STANDARD)
 - REMOVABLE LIFT OFF HINGE

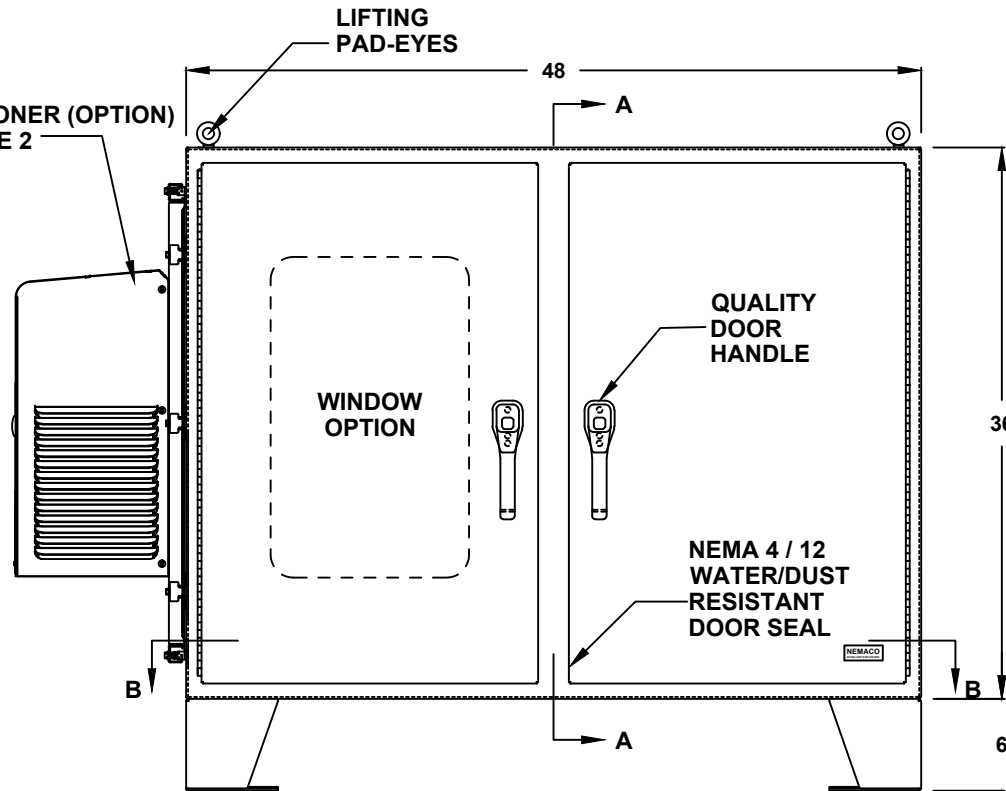

FRONT VIEW

- LIFTING EYES**
- WELDED PADEYES (STANDARD)
 - REMOVABLE PADEYES

- *WINDOW OPTIONS**
- TINTED WINDOW
 - TEMPERED GLASS
 - NOT REQUIRED

- DOOR HANDLES**
- PADLOCK PROVISION (STANDARD)
 - KEYLOCK (OPTION)

- FLOOR KIT**
- 6" HT. (STANDARD)
 - 8" HT.
 - 10" HT.
 - 12" HT.
 - CUSTOM _____

***NOTE: UL & NON-UL OPTIONS AVAILABLE**

COMPANY NAME

APPROVED (PRINTED NAME)

SIGNATURE

DATE

**36" H x 48" W x 48" D
4 DOOR DESIGN**

A/C MATERIAL (EXTERIOR)

- 304 STAINLESS STEEL
- 316 STAINLESS STEEL
- OTHER _____

AIR CONDITIONER

- 1000 BTU
- 1500 BTU
- 2000 BTU
- 3000 BTU
- 4000 BTU
- SPECIFY _____
- NOT REQUIRED

A/C VOLTAGE/ HZ

- 115 VOLTS
- 230 VOLTS
- 480 VOLTS
- 60 HZ
- 50 HZ
- 48 VDC (CS011 A/C ONLY)

A/C INTEGRATED HEATER

- 350 WATTS (CS011 A/C ONLY)
- 500 WATTS
- 1000 WATTS
- EXTERNAL HEATER

ADDITIONAL A/C OPTIONS

- CORROSION PROTECTION PACKAGE
- DRY CONTACT (OUTPUT SIGNAL)
- 2" DEEP FILTERS
- PROXIMITY SWITCH (ON/OFF)

AIR CONDITIONER- SCADA

- MOBUS RTU 485 (2 WIRE) REMOTE NETWORK ETHERNET CONNECTION
- MOBUS GATEWAY ADD-ON

THERMAL SPECIFICATIONS

- OUTSIDE (AMBIENT) _____ °F
- INTERIOR TEMP. _____ °F
- HEAT LOAD (WATTS) _____
- SUN / SHADE _____

ENCLOSURE INSULATION

- 1/2 RADIANT BARRIER (STANDARD)
- 3/4 RADIANT BARRIER
- 1 RADIANT BARRIER
- NOT REQUIRED

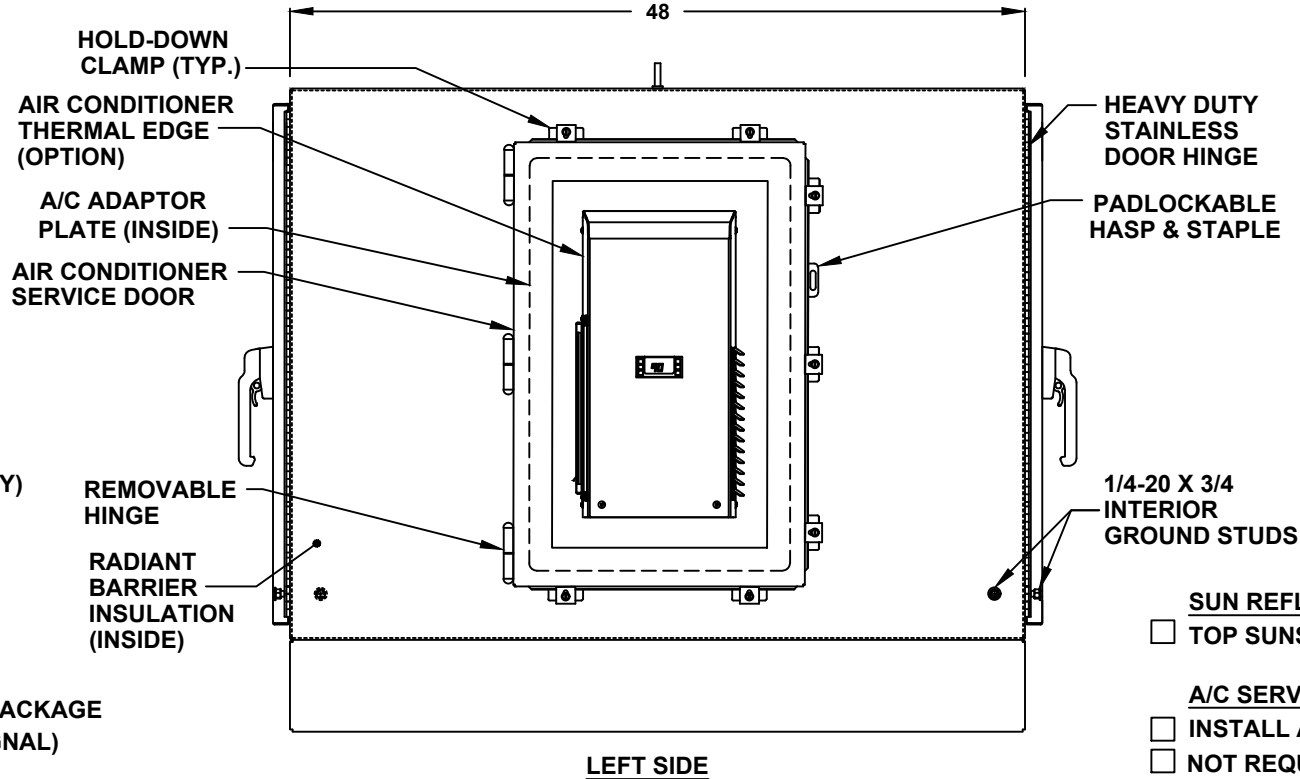

SUN REFLECTIVE SOLUTION

- TOP SUNSHIELD COVER

A/C SERVICE DOOR

- INSTALL A/C SERVICE DOOR
- NOT REQUIRED

A/C SERVICE DOOR HINGE

- REMOVABLE HINGE
- CONTINUOUS HINGE

A/C ADAPTOR PLATE

- INSTALL A/C ADAPTOR PLATE
- NOT REQUIRED

36" H x 48" W x 48" D 4 DOOR DESIGN

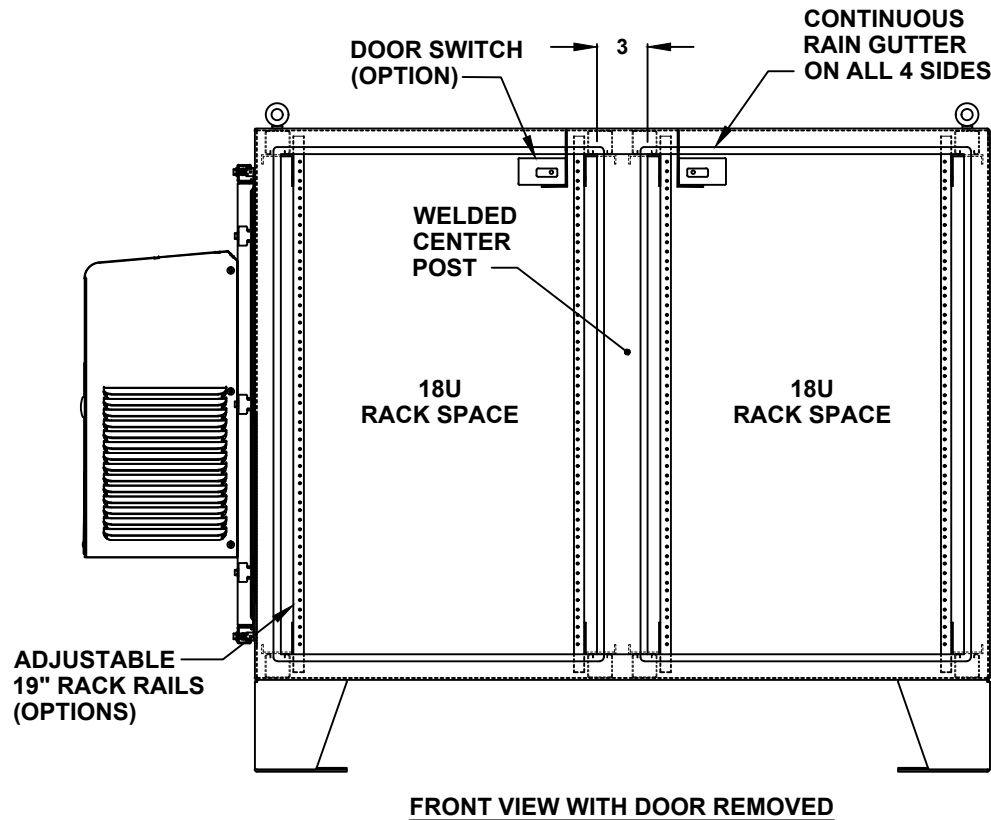

DOOR OPTIONS

- DOOR SWITCH
 - 10A (STANDARD)
 - 16A
- PRINT POCKET

CENTER POST

- WELDED (STANDARD)
- REMOVEABLE

RACK RAIL POST

- QTY 4 POST
- QTY 8 POST (REARDOOR REQUIRED)

RACK RAIL MATERIAL

- POWDER COATED STEEL (STANDARD)
- 304 STAINLESS STEEL (HEAVY DUTY)

RACK RAIL MOUNTING HOLES

- #10-32 TAP (STANDARD)
- #1/4-20 TAP
- 3/8 SQUARE

36" H x 48" W x 48" D
4 DOOR DESIGN

- RACK SHELVES**
- STANDARD RACK SHELVES
 - SLIDING RACK SHELVES
 - RACK SHELF SUPPORT
- RACK DRAWERS**
- RACK DRAWERS
 - LAPTOP DRAWERS
- RACK RAIL HARDWARE**
- BLACK CLIP NUTS, #10-32, (100 EA.)
 - #10/32 HIGH POINT SCREWS (100 EA.)
 - M6 CAGE NUTS
- OTHER OPTIONS**
- 19" RACK COPPER BUSBAR
 - VERTICAL RACK PDU

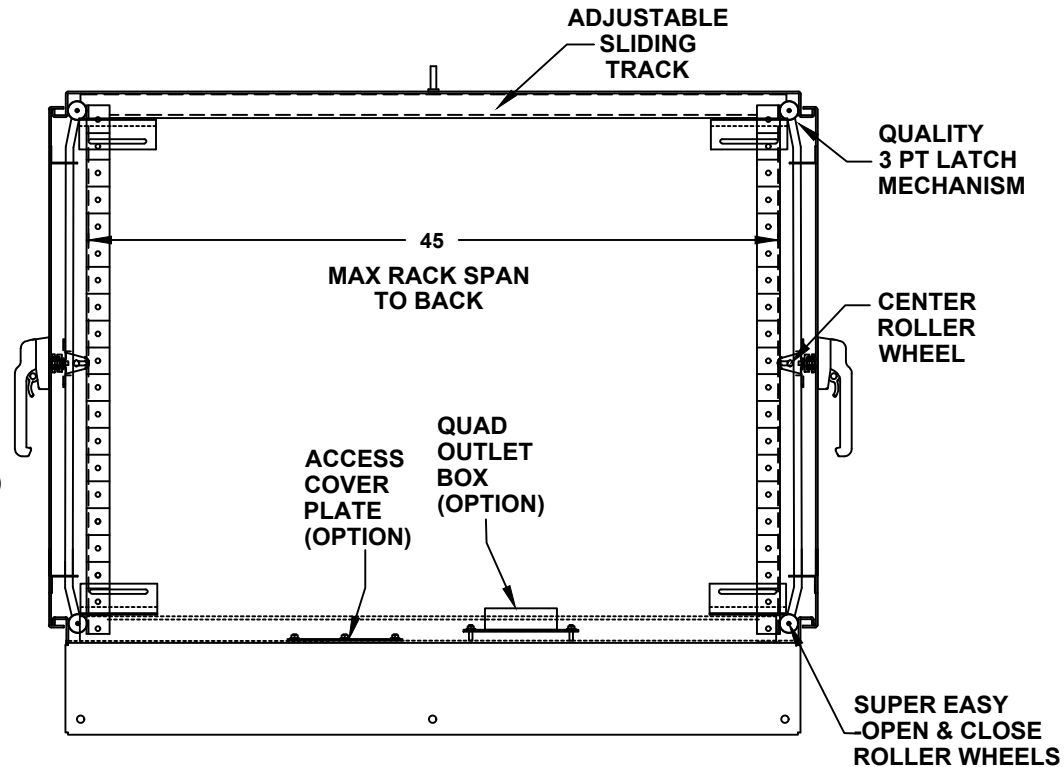

CROSS SECTION VIEW A-A

36" H x 48" W x 48" D 4 DOOR DESIGN

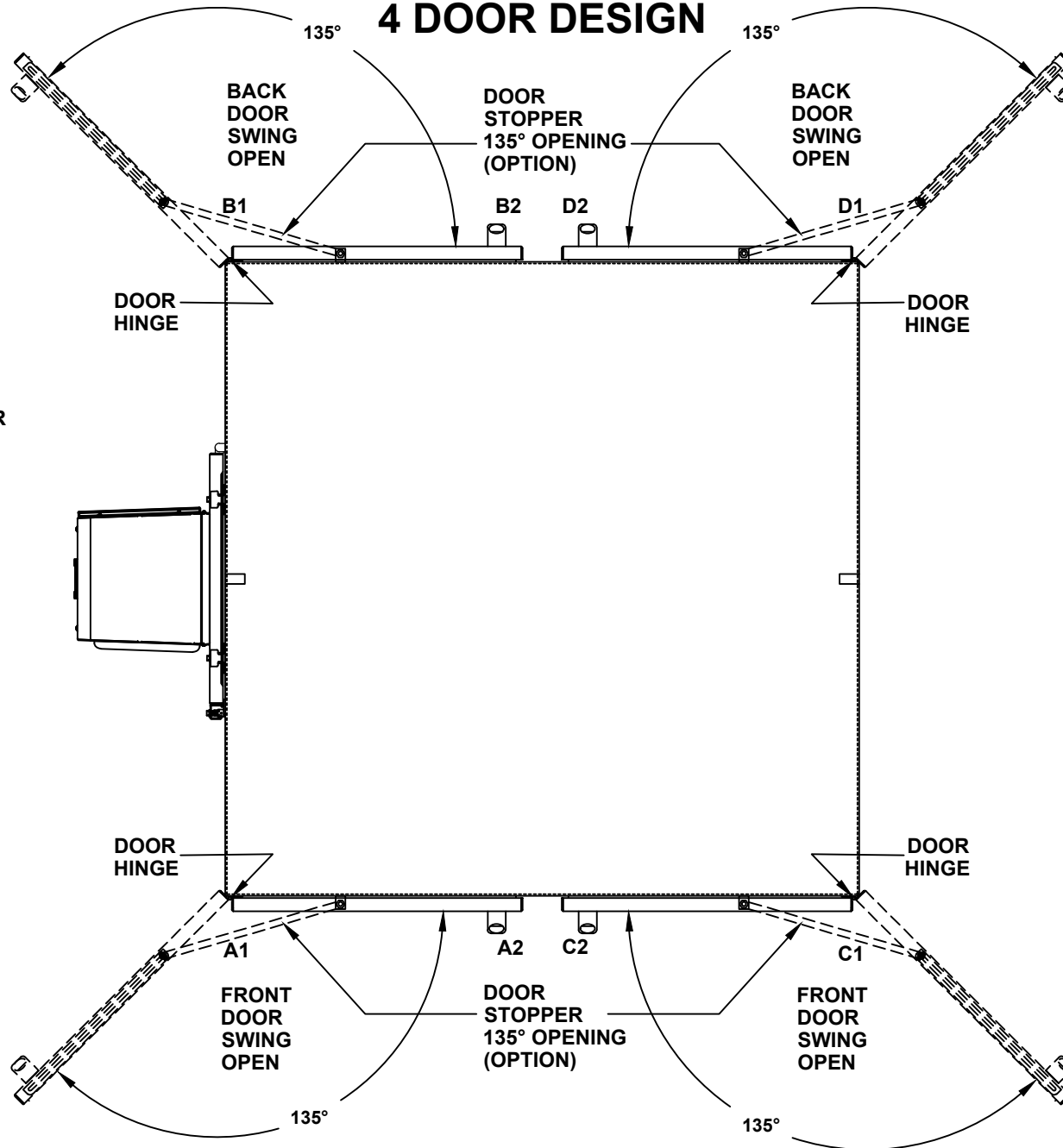

- DOOR STOPPER**
- INSTALL DOOR STOPPER
 - NOT REQUIRED

TOP VIEW

36" H x 48" W x 48" D 4 DOOR DESIGN

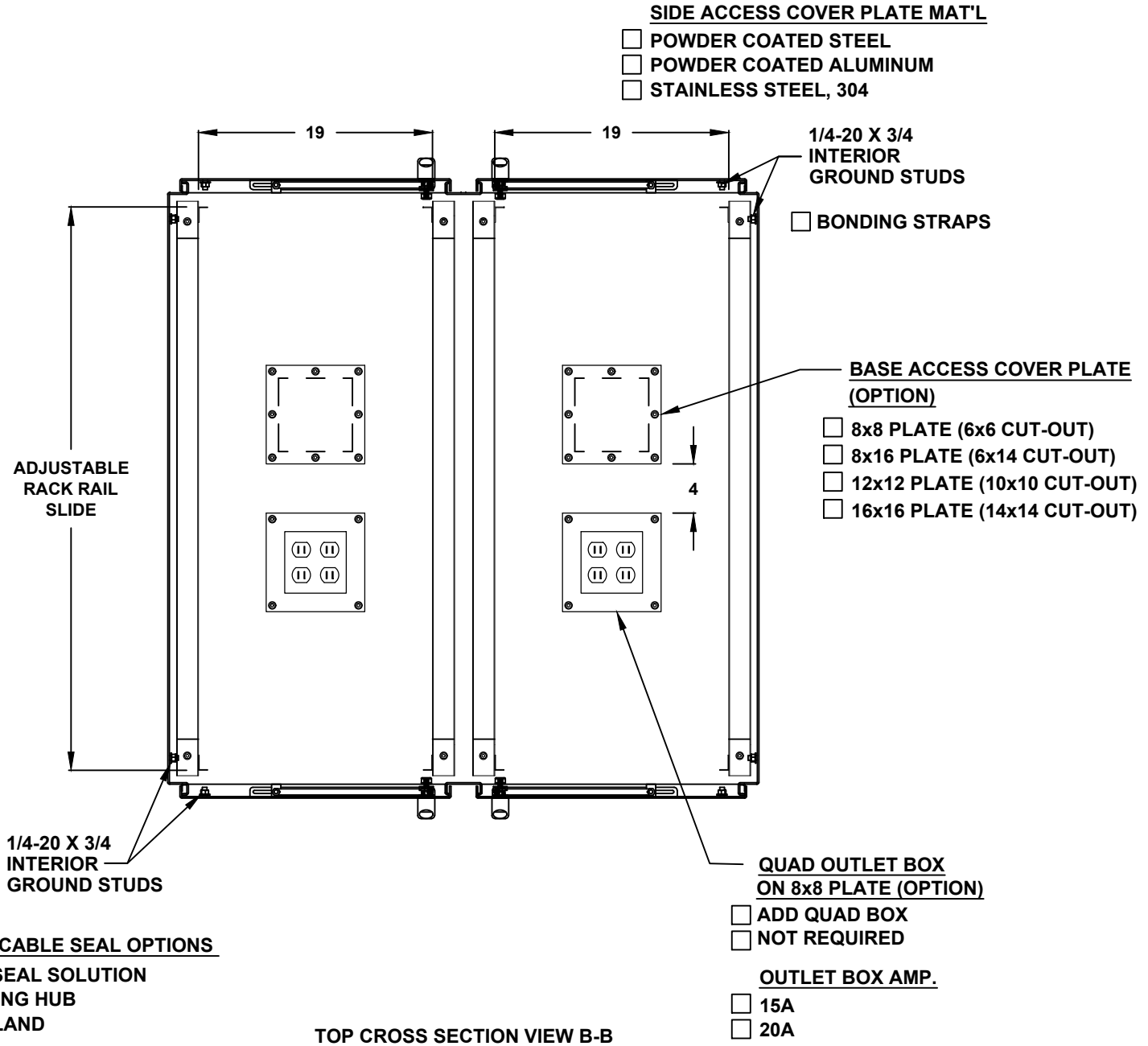

36" H x 48" W x 48" D
4 DOOR DESIGN

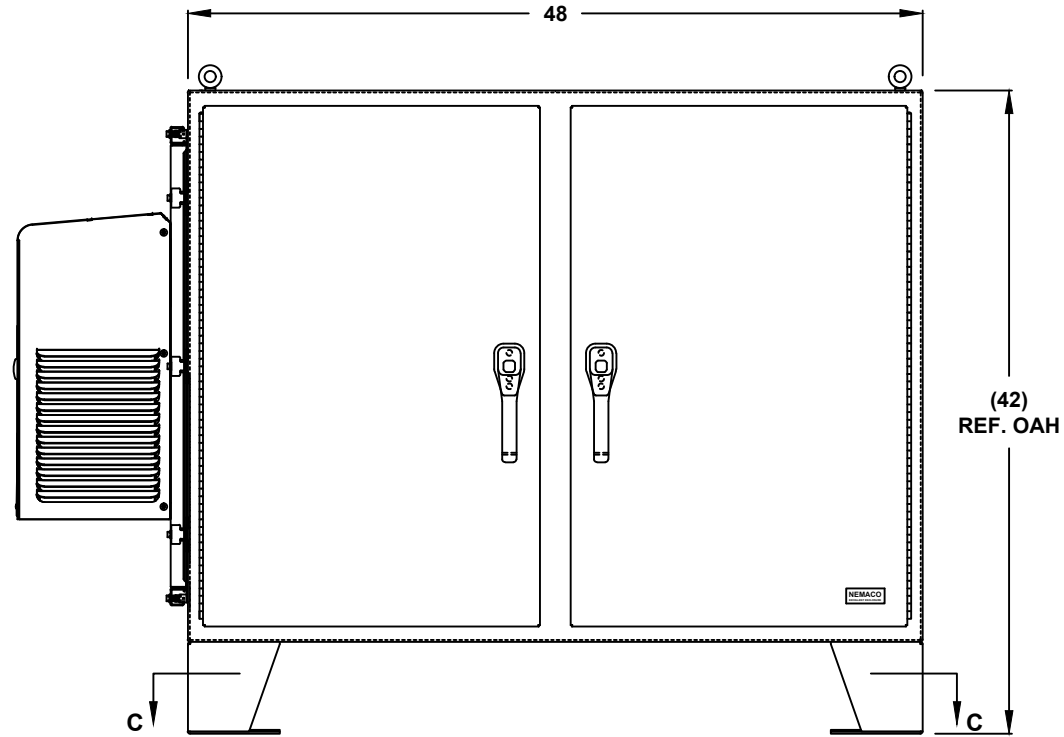

FRONT VIEW

36" H x 48" W x 48" D 4 DOOR DESIGN

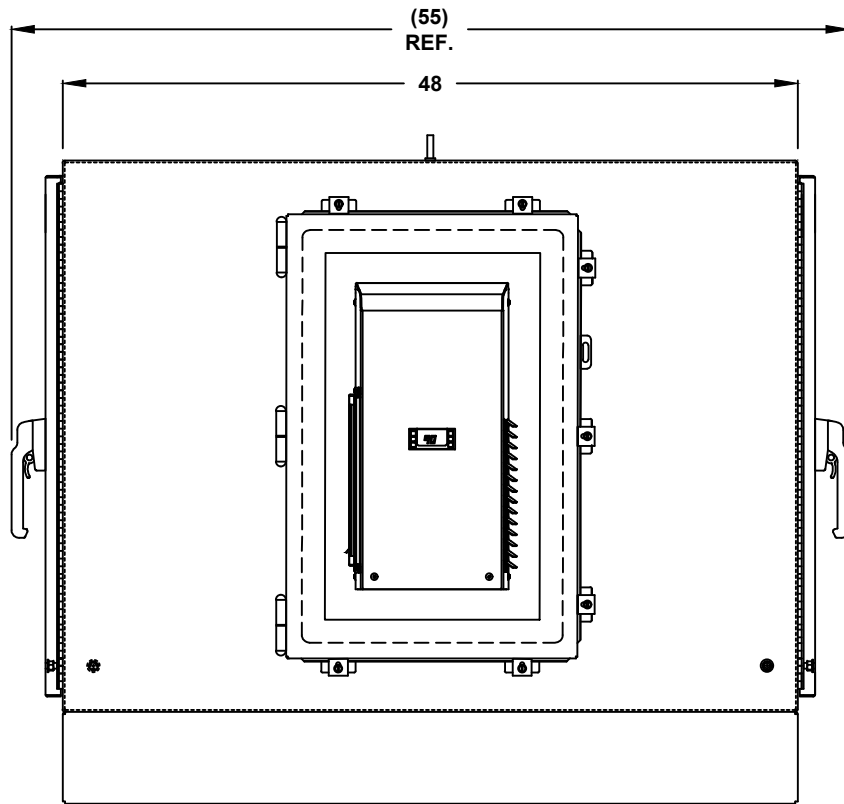

LEFT SIDE

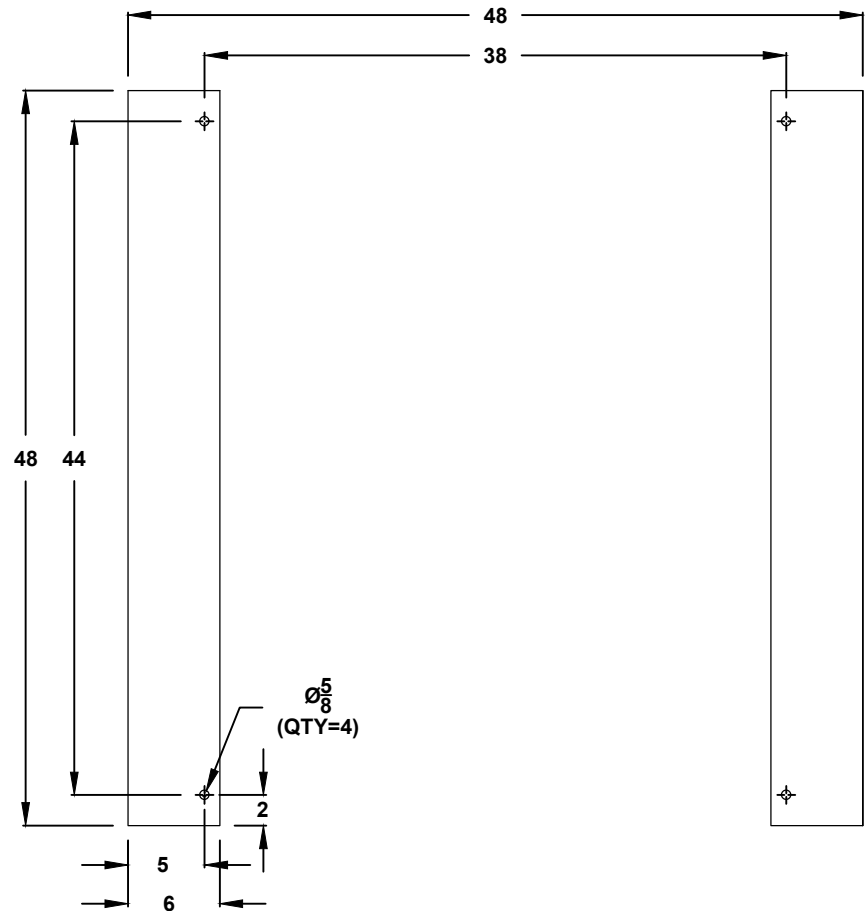

CROSS SECTION VIEW C-C
MOUNTING HOLES