

**NEMA 4/12 - ENCLOSURE
19" RACKMOUNT - 12U HEIGHT
FREE STANDING**

**24" H x 48" W x 48" D
4 DOOR DESIGN**



FILE NUMBER: E507642

- ENCLOSURE MATERIAL**
- POWDER COATED STEEL (CS)
 - POWDER COATED ALUMINUM (AL)

- POWDERCOAT COLOR**
- WHITE
 - LIGHT GRAY ANSI 70
 - DARK GRAY ANSI 61 (STANDARD)
 - BLACK
 - CUSTOM _____

- ENCLOSURE CONSTRUCTION**
- 14 GA THK.
 - 12 GA THK.

- ENCLOSURE DOOR HINGE**
- CONTINUOUS PIANO HINGE (STANDARD)
 - REMOVABLE LIFT OFF HINGE

- BASE EXTENSION**
- 4" BASE EXTENSION
 - 6" BASE EXTENSION
 - 8" BASE EXTENSION
 - 10" BASE EXTENSION
 - 12" BASE EXTENSION
 - NOT REQUIRED

**AIR CONDITIONER (OPTION)
REF. TO PAGE 2**

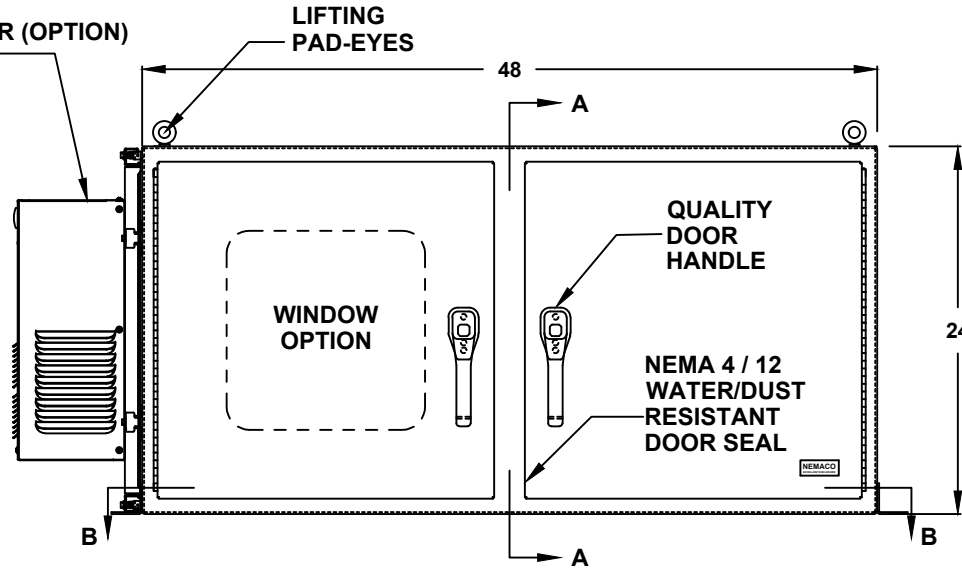

FRONT VIEW

- LIFTING EYES**
- WELDED PADEYES (STANDARD)
 - REMOVABLE PADEYES

- *WINDOW OPTIONS**
- TINTED WINDOW
 - TEMPERED GLASS
 - NOT REQUIRED

- DOOR HANDLES**
- PADLOCK PROVISION (STANDARD)
 - KEYLOCK

**ALL DIMENSIONS ARE ESTIMATED IN INCHES
AND MAY VARY DUE TO SELECTED OPTIONS.**

COMPANY NAME

APPROVED (PRINTED NAME)

SIGNATURE

DATE

***NOTE: UL & NON-UL OPTIONS
AVAILABLE**

24" H x 48" W x 48" D
4 DOOR DESIGN

AIR CONDITIONER

- 1000 BTU (NE/CS)
- 1500 BTU (NE)
- 2000 BTU (CS)
- SPECIFY _____
- NOT REQUIRED

A/C VOLTAGE/ HZ

- 115 VOLTS
- 230 VOLTS
- 480 VOLTS
- 60 HZ
- 50 HZ
- 48 VDC (CS011 A/C ONLY)

A/C INTEGRATED HEATER

- 350 WATTS (CS011 A/C ONLY)
- 500 WATTS
- 1000 WATTS
- EXTERNAL HEATER

ADDITIONAL A/C OPTIONS

- CORROSION PROTECTION PACKAGE
- DRY CONTACT (OUTPUT SIGNAL)
- 2" DEEP FILTERS
- PROXIMITY SWITCH (ON/OFF)

AIR CONDITIONER- SCADA

- MOBUS RTU 485 (2 WIRE) REMOTE NETWORK ETHERNET CONNECTION
- MOBUS GATEWAY ADD-ON

AIR CONDITIONER- SCADA

- MOBUS RTU 485 (2 WIRE) REMOTE NETWORK ETHERNET CONNECTION
- MOBUS GATEWAY ADD-ON

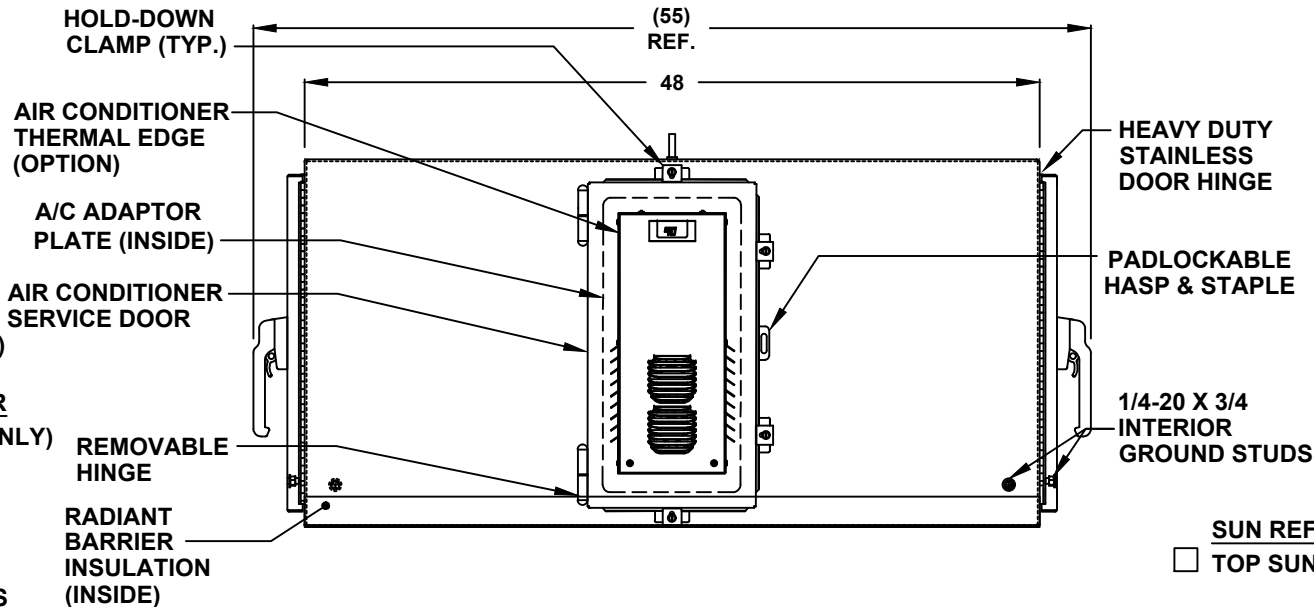

LEFT SIDE

THERMAL SPECIFICATIONS

- OUTSIDE (AMBIENT) _____ °F
- INTERIOR TEMP. _____ °F
- HEAT LOAD (WATTS) _____
- SUN / SHADE _____

ENCLOSURE INSULATION

- 1/2 RADIANT BARRIER (STANDARD)
- 3/4 RADIANT BARRIER
- 1 RADIANT BARRIER
- NOT REQUIRED

SUN REFLECTIVE SOLUTION

- TOP SUNSHIELD COVER

A/C SERVICE DOOR

- INSTALL A/C SERVICE DOOR
- NOT REQUIRED

A/C SERVICE DOOR HINGE

- REMOVABLE HINGE
- CONTINUOUS HINGE

A/C ADAPTOR PLATE

- INSTALL A/C ADAPTOR PLATE
- NOT REQUIRED

**24" H x 48" W x 48" D
4 DOOR DESIGN**

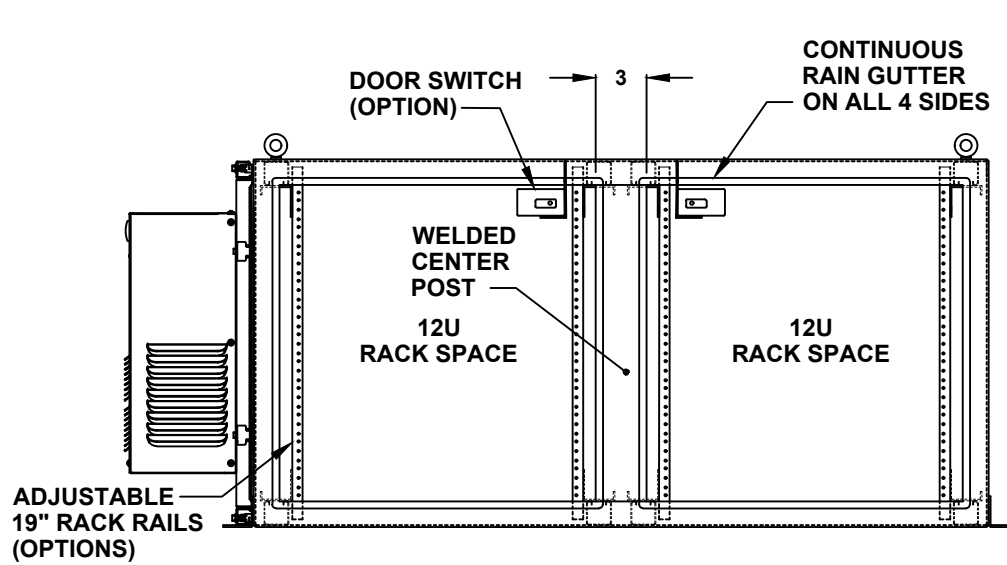

FRONT VIEW WITH DOOR REMOVED

DOOR OPTIONS

- DOOR SWITCH
 - 10A (STANDARD)
 - 16A
- PRINT POCKET

CENTER POST

- WELDED (STANDARD)
- REMOVEABLE

RACK RAIL POST

- QTY 4 POST
- QTY 8 POST (REARDOOR REQUIRED)

RACK RAIL MATERIAL

- POWDER COATED STEEL (STANDARD)
- 304 STAINLESS STEEL (HEAVY DUTY)

RACK RAIL MOUNTING HOLES

- #10-32 TAP (STANDARD)
- #1/4-20 TAP
- 3/8 SQUARE

24" H x 48" W x 48" D
4 DOOR DESIGN

- RACK SHELVES**
- STANDARD RACK SHELVES
 - SLIDING RACK SHELVES
 - RACK SHELF SUPPORT

- RACK DRAWERS**
- RACK DRAWERS
 - LAPTOP DRAWERS

- RACK RAIL HARDWARE**
- BLACK CLIP NUTS, #10-32, (100 EA.)
 - #10/32 HIGH POINT SCREWS (100 EA.)
 - M6 CAGE NUTS

- OTHER OPTIONS**
- 19" RACK COPPER BUSBAR
 - VERTICAL RACK PDU

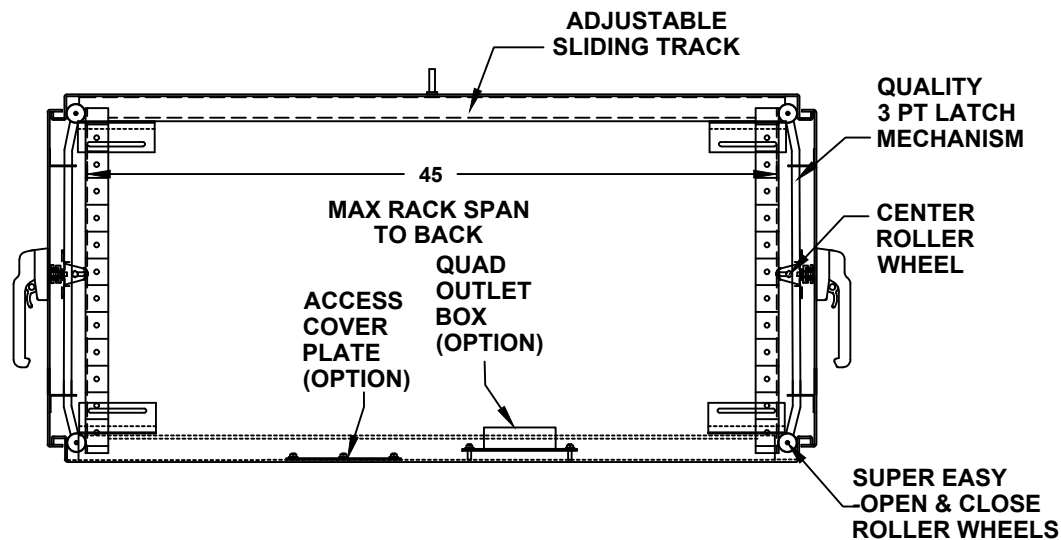

CROSS SECTION VIEW A-A

24" H x 48" W x 48" D 4 DOOR DESIGN

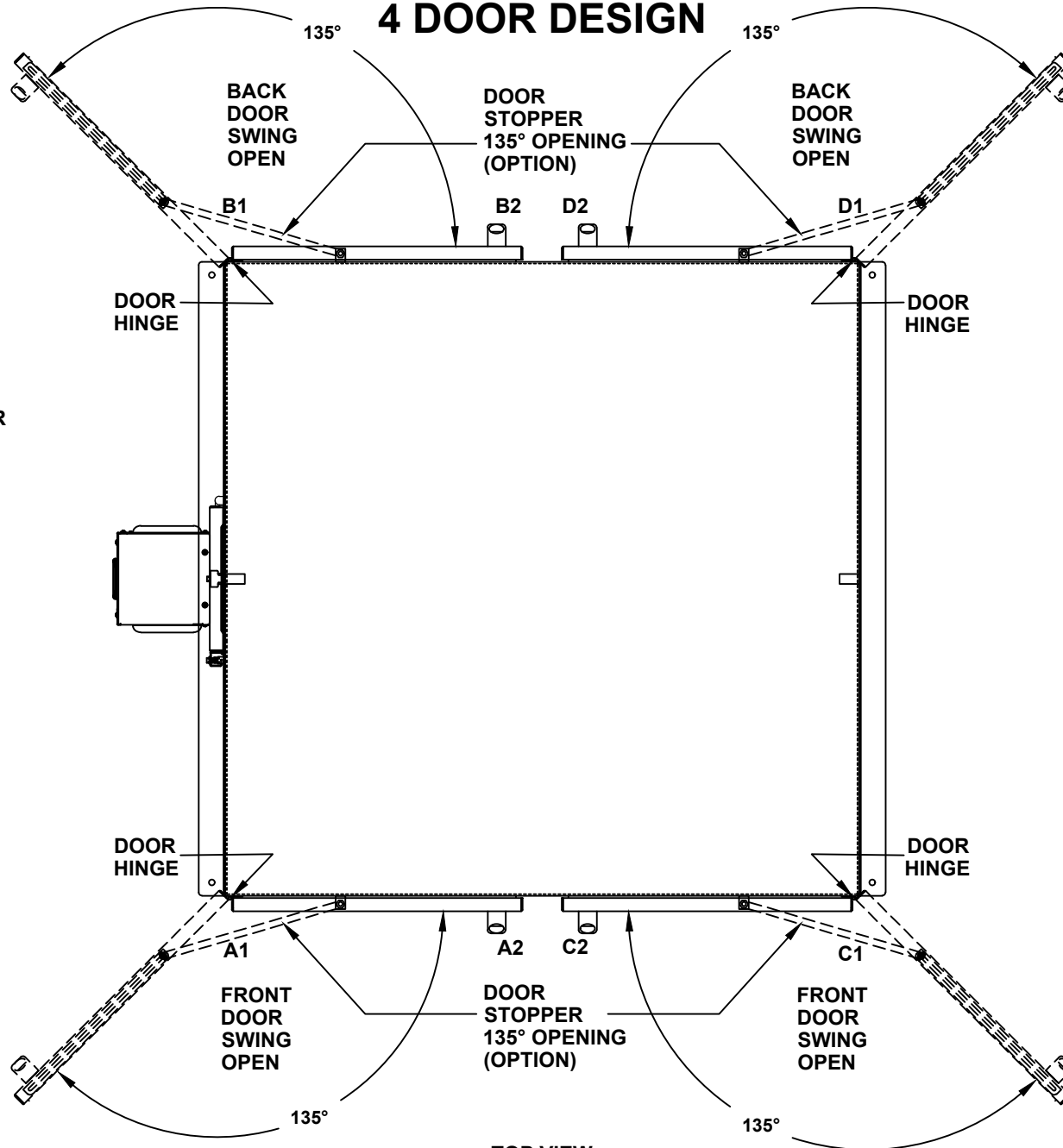

- DOOR STOPPER**
- INSTALL DOOR STOPPER
 - NOT REQUIRED

TOP VIEW

24" H x 48" W x 48" D 4 DOOR DESIGN

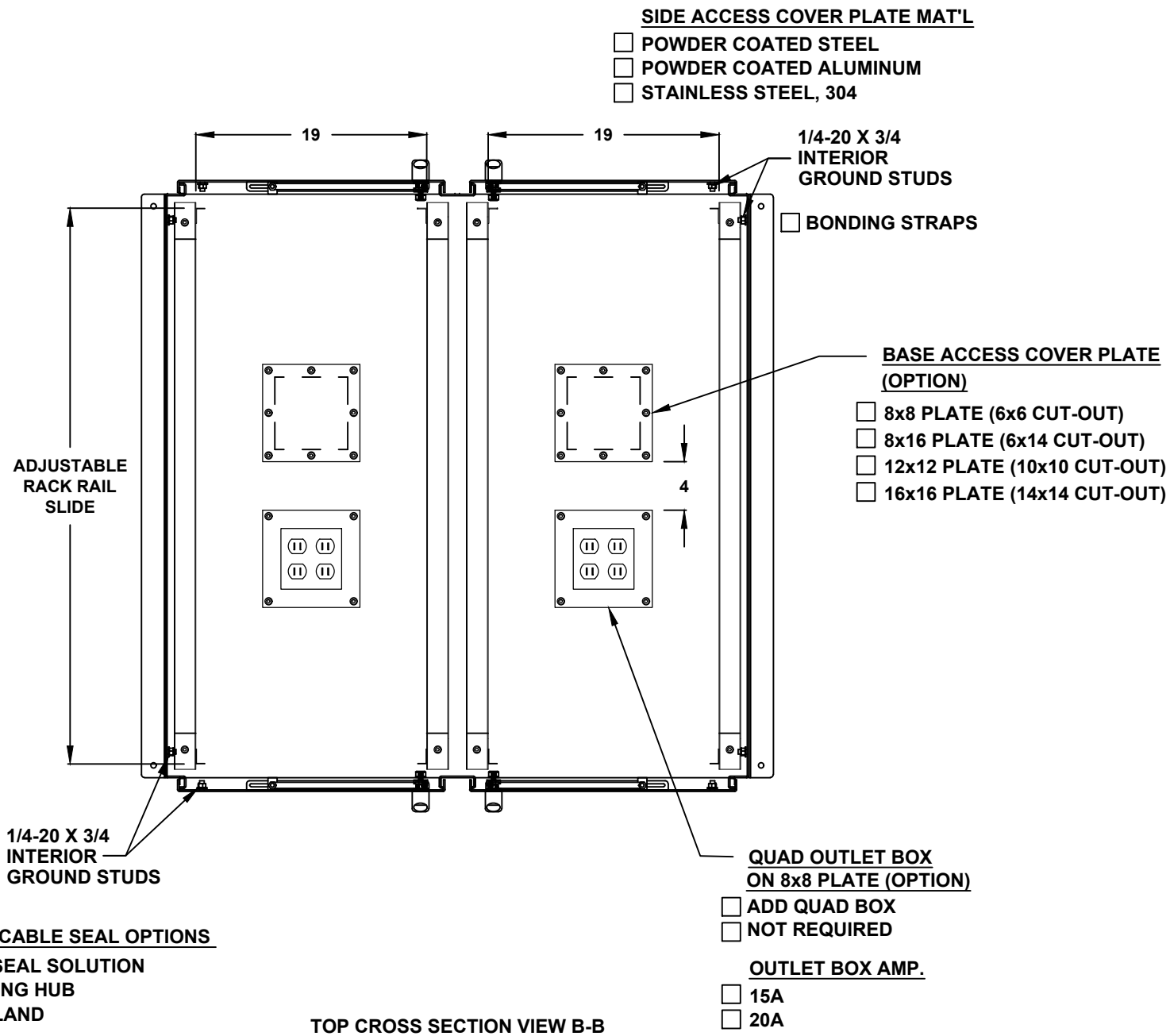

TOP CROSS SECTION VIEW B-B

24" H x 48" W x 48" D 4 DOOR DESIGN

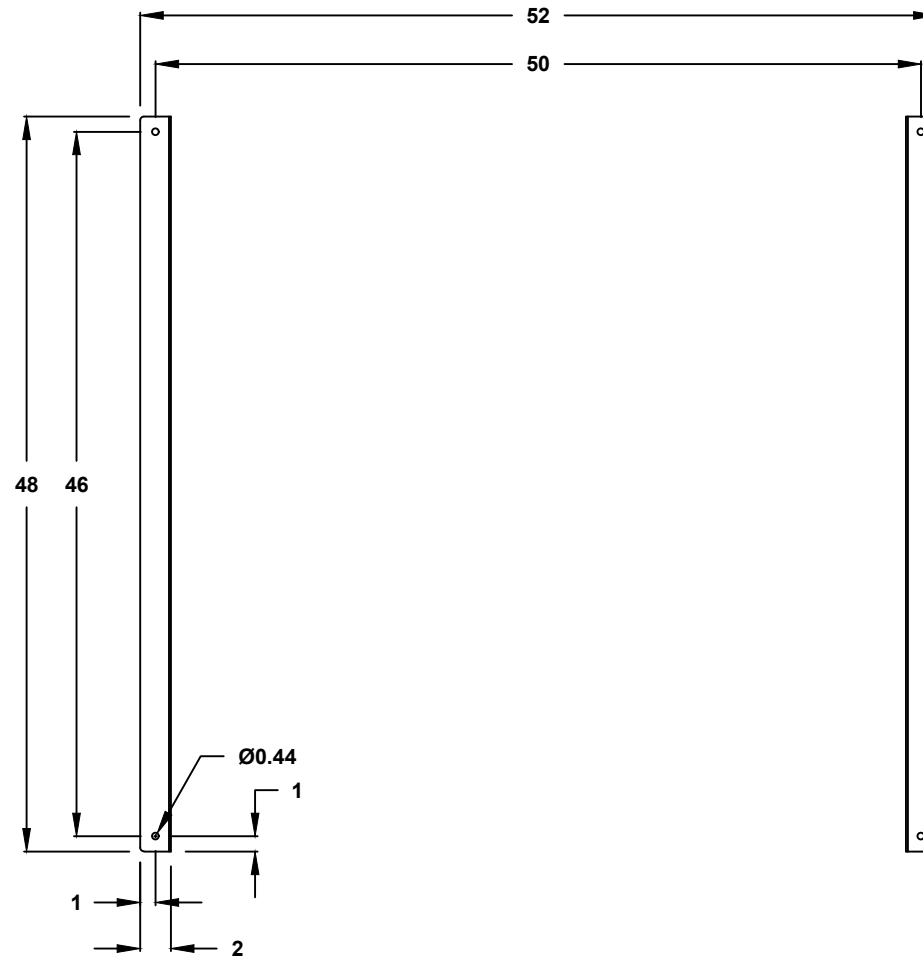

CROSS SECTION VIEW B-B
MOUNTING HOLES